



MPO/MTP HYBRID PATCHCORD

Lightem offers a full range of MPO/MTP multifiber products, ranging from patchcords, fanout hybrid cable, truck cable, pigtails and cassette. The MPO/MTP, with the push-on/pull-off insertion release mechanism, provides consistent and repeatable interconnections up to 48 fibers for today's 40G and 100G network. MPO/MTP hybrid cable are custom-built with various type of connectors and special configuration. All connectors are factory polished and terminated with full testing before delivery.

Features

- Up to 24 fibers MTP/MPO per connector
- Halogen free (LSZH) and low smoke to IEC 61034 and EN 50286
- Flame retardant to IEC 60332-3C and EN 50266-2-4
- Non corrosive to IEC 60754-2 (FRNC) and EN 50267
- A pre-terminated, easy-to-install, high fiber density cabling solution
- Pre-installed grip option supports up to 450N loads.
- Singlemode, OM3, OM4 and OM5 fibers
- MTP / MPO connector complying ANSI HIPPI-6400 and IEC 61754-7 and TIA/EIA-604

Applications

- Equipment Interconnections
- Telecommunications networks
- Broadband/CATV networks
- Data communications networks, including high-bandwidth equipment
- Interconnections for parallel optical transmitters and receivers

100% Lightem Assurance

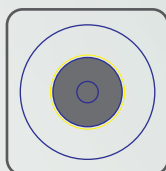

Connector Surface Inspection

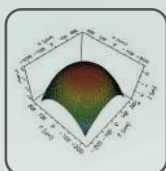

Geometric Inspection

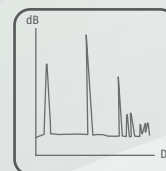

Optical Inspection

Termination Specifications

Parameter	MPO / MTP Values					
	Standard			Premium		
	SM		MM	SM		MM
UPC	APC	UPC		APC		
Insertion loss (each channel)	≤0.75 dB	≤0.75 dB	≤0.5 dB	≤0.35dB	≤0.35dB	≤0.35 dB
Return loss (each channel)	≤-40 dB	≤-55 dB	/	≤-40dB	≤-55dB	/
Test Wavelength	1310nm			850nm		
Ferrule	Composite					
Connector housing	Composite					
Durability	≤0.2 dB at 200 cycles					
Operating Temperature	-20° C ~ +70° C					
Storage Temperature	-20° C ~ +70° C					

Parameter	SC/LC		
	Standard		MM
	SM		
	UPC	APC	
Insertion loss (each channel)		<0.3 dB	<-25 dB
Return loss (each channel)	<-50 dB	<-65 dB	/
Test Wavelength	1310nm		
Ferrule	Composite		
Connector housing	Composite		
Durability	≤0.2 dB at 200 cycles		
Operating Temperature	-40° C ~ +85° C		

Product MPO-LC/SC Diagram

12A - 12 Fibers, 5-8 channels unuse

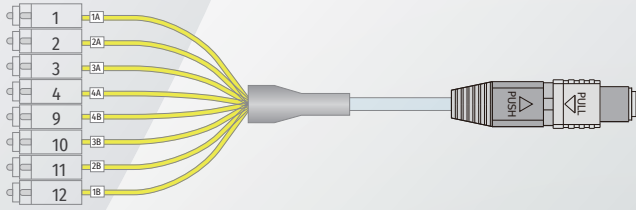

Fiber	Marker
1	1A
2	2A
3	3A
4	4A
5	N/A
6	N/A
7	N/A
8	N/A
9	4B
10	3B
11	2B
12	1B

12F - 12 fibers all channels use

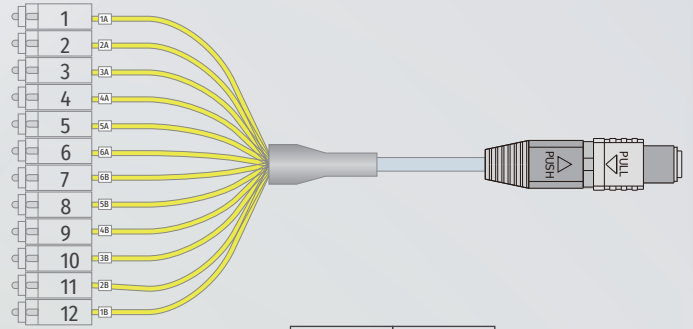

Fiber	Marker
1	1A
2	2A
3	3A
4	4A
5	5A
6	6A
7	6B
8	5B
9	4B
10	3B
11	2B
12	1B

24A - 24 fibers, 1, 12, 13, 24 channels unuse

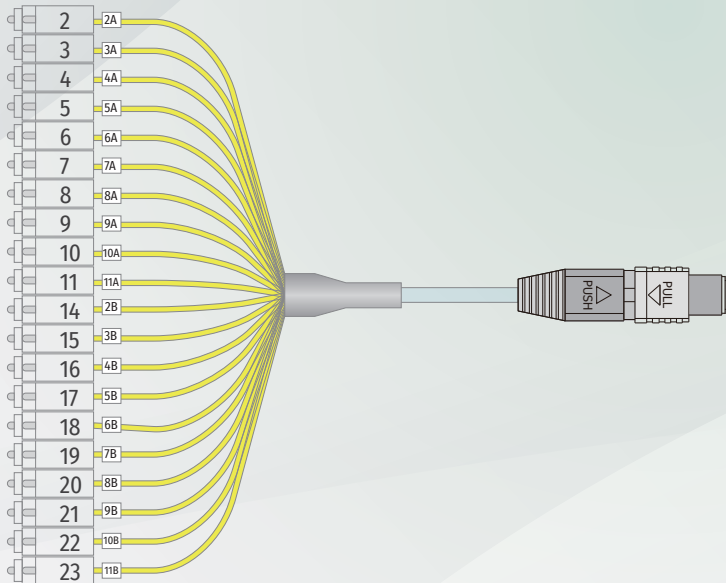

Marker	Fiber
N/A	N/A
2B	14
3B	15
4B	16
5B	17
6B	18
7B	19
8B	20
9B	21
10B	22
11B	23
N/A	N/A

Fiber	Marker
N/A	N/A
2	2A
3	3A
4	4A
5	5A
6	6A
7	7A
8	8A
9	9A
10	10A
11	11A
12	N/A

24F - 24 fibers all channels use

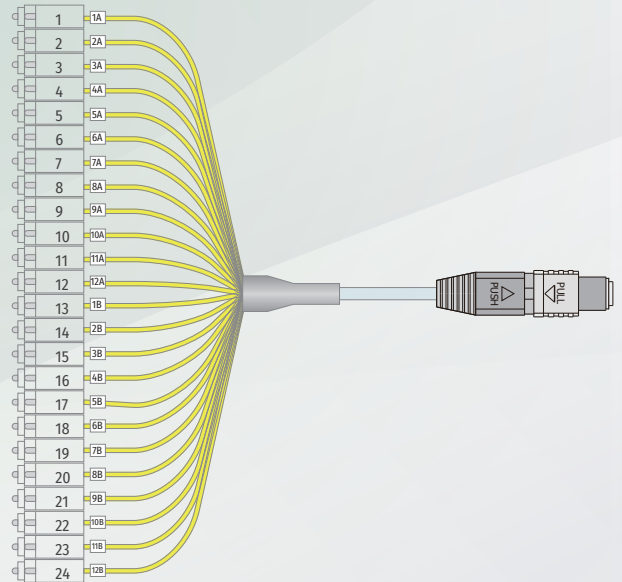

Marker	Fiber
1B	13
2B	14
3B	15
4B	16
5B	17
6B	18
7B	19
8B	20
9B	21
10B	22
11B	23
12B	24

Fiber	Marker
1	1A
2	2A
3	3A
4	4A
5	5A
6	6A
7	7A
8	8A
9	9A
10	10A
11	11A
12	12A

MPO Connector Pinouts

12A- 12 fibers, 5-8 channels unuse

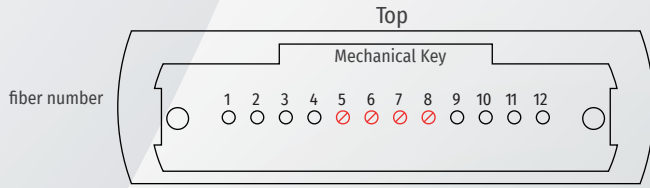

12F - 12 fibers all channels use

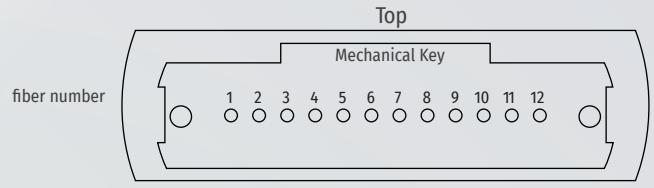

24A - 24 fibers, 1, 12, 13, 24 channels unuse

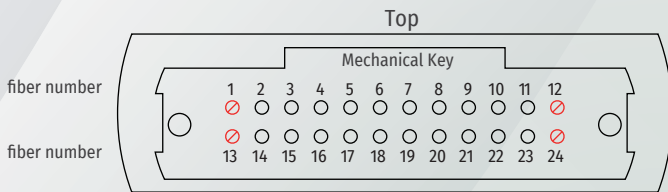

24F - 24 fibers all channels use

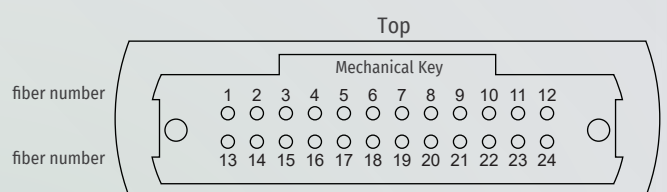

- Used
- ⊗ Not used

Fiber Specifications (Singlemode)

Characteristics		G652D	G657A1	G657A2
Optical Characteristics				
Attenuation	1310nm	≤ 0.40 dB/km	≤ 0.40 dB/km	≤ 0.40 dB/km
	1383nm*	≤ 0.34 dB/km	≤ 0.35 dB/km	≤ 0.35 dB/km
	1460nm*	-	≤ 0.25 dB/km	≤ 0.25 dB/km
	1490nm*	-	-	≤ 0.23 dB/km
	1550nm	≤ 0.30 dB/km	≤ 0.30 dB/km	≤ 0.30 dB/km
	1625nm*	≤ 0.23 dB/km	≤ 0.23 dB/km	≤ 0.23 dB/km
	Attenuation vs. Wavelength	1285-1330nm*	≤ 0.03 dB/km	≤ 0.03 dB/km
Max. α difference	1525-1575nm*	≤ 0.02 dB/km	≤ 0.02 dB/km	≤ 0.02 dB/km
Dispersion coefficient	1285-1340nm	≥ -3.4 ≤ 3.4 ps/(nm · km)	≥ -3.4 ≤ 3.4 ps/(nm · km)	-
	1550nm	≤ 18 ps/(nm · km)	≤ 18 ps/(nm · km)	-
	1625nm	≤ 22 ps/(nm · km)	≤ 22 ps/(nm · km)	-
Zero dispersion wavelength		1312±12 nm	1300-1324 nm	1300-1324 nm
Zero dispersion slope		≤ 0.091 ps/nm ² · km	≤ 0.092 ps/nm ² · km	≤ 0.092 ps/nm ² · km
Typical value		0.086 ps/nm ² · km	0.086 ps/nm ² · km	0.04 ps/nm ² · km
PMD				
Maximum Individual Fibre		≤ 0.1 ps/√km	≤ 0.1 ps/√km	≤ 0.1 ps/√km
Link Design Value(M=20,Q=0.01%)		≤ 0.06 ps/√km	≤ 0.06 ps/√km	≤ 0.06 ps/√km
	Typical value	0.04 ps/√km	0.04 ps/√km	0.04 ps/√km
Cable cutoff wavelength λ _{cc}		≤ 1260 nm	≤ 1260 nm	≤ 1260 nm
Mode field diameter(MFD)	1310nm	8.7-9.5 μm	8.4-9.2 μm	8.4-9.2 μm
	1550nm	9.9-10.9 μm	9.3-10.3 μm	9.3-10.3 μm
Effective group index of refraction(N _{eff})	1310nm	1.466	1.466	1.466
	1550nm	1.467	1.467	1.467
Point discontinuities	1310nm	≤ 0.05 dB	≤ 0.05 dB	≤ 0.05 dB
	1550nm	≤ 0.05 dB	≤ 0.05 dB	≤ 0.05 dB
Geometrical Characteristics				
Cladding diameter		125.0±0.7 μm	125.0±0.7 μm	125.0±0.7 μm
Cladding non-circularity		≤ 1.0 %	≤ 0.7 %	≤ 0.7 %
Coating diameter		245.0±7 μm	245.0±5 μm	245.0±5 μm
Coating-cladding concentricity error		≤ 12.0 μm	≤ 12.0 μm	≤ 12.0 μm
Coating non-circularity		≤ 6.0 %	≤ 6.0 %	≤ 6.0 %
Core-cladding concentricity error		≤ 0.6 μm	≤ 0.5 μm	≤ 0.5 μm
Curl(radius)		≥ 4 m	≥ 4 m	≥ 4 m
Delivery length		2.1 to 50.4 km/reel	2.1 to 50.4 km/reel	2.1 to 50.4 km/keel

*Attenuation loss of barefiber

Fiber Specifications (Multimode)

Characteristics		OM3/OM4	OM5
Geometry Characteristics			
Core Diameter		50±2.5 μm	50±2.5 μm
Core Non-circularity		≤5.0 %	≤5.0 %
Cladding Diameter		125.0±1.0 μm	125.050±1.0 μm
Cladding Non-circularity		≤0.6 %	≤0.6 %
Coating Diameter		245±7 μm	245±7 μm
Coating/Cladding Concentricity Error		≤10.0 μm	≤10.0 μm
Coating Non-circularity		≤6.0 %	≤6.0 %
Core/Cladding Concentricity Error		≤1.0 μm	≤1.0 μm
Delivery Length		up to 8.8 km/ reel	up to 8.8 km/ reel
Optical Characteristics			
Attenuation	850nm	≤3.5 dB/km	≤3.5 dB/km
	953nm*	-	≤1.7 dB/km
	1300nm	≤1.5 dB/km	≤1.5 dB/km
Overfilled Modal Bandwidth	850nm	≥1500/≥3500 MHz · km	≥3500 MHz · km
	953nm	-	≥1850 MHz · km
	1300nm	≥500/≥500 MHz · km	≥500 MHz · km
Effective Modal Bandwidth	850nm	≥2000/≥4700 MHz · km	≥4700 MHz · km
	953nm	-	≥2470 MHz · km
10Gb/sWDM		-100/150 m	150 m
40Gb/sWDM		300/500 m	440 m
40GBASE-SR4 / 100GBASE SR10	850nm	1000/1100 m	200 m
10GBASE-SR	850nm	-	-
1000BASE-SR	850nm	-	-
DMD Specification		-	-
Numerical Aperture		0.200±0.015	0.200±0.015
Group Refractive index		1.482	1.482
		1.477	1.477
Zero Dispersion Wavelength, λ ₀		1295-1340 nm	1297-1328 nm
Zero Dispersion Slope, S ₀		-	≤4(-103)/(840λ√840) ⁴ ps/nm ² · km
		-	-
Zero Dispersion Slope, S ₀	1295nm ≤ λ ₀ ≤ 1310nm	≤0.105 ps/nm ² · km	-
	1310nm ≤ λ ₀ ≤ 1340nm	-	-
	1320nm ≤ λ ₀ ≤ 1348nm	≤0.000375(1590-λ ₀)ps/nm ² · km	-
	1348nm ≤ λ ₀ ≤ 1365nm	-	-

*Attenuation loss of barefiber

Ordering Information

